

# CE cRU<sub>us</sub> -100°C to +1000°C, 2 relay multi-sensor type electronic thermostats

Devices designed to display, control and regulate heating or cooling generators, with input for NTC, PTC(KTY), Pt 100, Thermocouple J and Thermocouple K. type sensors. Both outputs with changeover relays can be configured for 2 independent stages, 2 related stages, neutral zone, or also as 1 stage + alarm.

## 1- Versions and references

MODEL	MOUNTING	RELAYS	POWER SUPPLY, 50/60 Hz
AKO-14724	PANEL MOUNTING	8 A, 250 V, cos φ=1, SPDT	12 V ± ±20%
AKO-14725	PANEL MOUNTING	8 A, 250 V, cos φ=1, SPDT	120 V ~ +8% -12%
AKO-14726	PANEL MOUNTING	8 A, 250 V, cos φ=1, SPDT	230 V ~ ±10%
AKO-15225	DIN RAIL	8 A, 250 V, cos φ=1, SPDT	120 V ~ +8% -12%
AKO-15226	DIN RAIL	8 A, 250 V, cos φ=1, SPDT	230 V ~ ±10%
AKO-15227	DIN RAIL	8 A, 250 V, cos φ=1, SPDT	24 V ± ±20%

## 2- Technical data

Temperature range according to type of sensor supplied by AKO:

- NTC (ntc) ..... -50.0 °C to 105 °C (-58.0 °F to 221 °F)
- PTC (PtC) tipo KTY ..... -50.0 °C to 150 °C (-58.0 °F to 302 °F)
- Pt 100 (Pt1) ..... -100 °C to 440 °C (-148 °F to 824 °F)
- J Thermocouple (JtC) ..... 0 °C to 600 °C (32 °F to 999 °F)
- K Thermocouple (KtC) ..... 0 °C to 999 °C (32 °F to 999 °F)

Resolution, Set Point and differential (NTC, PTC, Pt 100): ..... 0.1 °C  
 Resolution, Set Point and differential (J or K thermocouple): ..... 1 °C  
 Thermometric accuracy (NTC, PTC, Pt 100): ..... ± 1 °C  
 Thermometric accuracy (J or K thermocouple): ..... ± 2 °C  
 Maximum input power: ..... 3 VA  
 Working ambient temperature: ..... 5 °C to 50 °C  
 Storage ambient temperature: ..... -30 °C to 70 °C  
 Control device classification: Independent mounting, with characteristic of automatic operation Type 1.B action, to be used in a clean situation, logical medium (software) class A.  
 Double insulation between the power supply, the secondary circuit and the relay output.  
 Allocated pulse voltage: ..... 800 V  
 Pressure ball test temperature:  
 Accessible parts: ..... 75 °C  
 Parts that position active elements: ..... 125 °C  
 Voltage and current declared by the EMC tests: ..... 207 V, 9 mA

## 3- Installation

The controller should be installed in a place protected from vibrations, water and corrosive gases, and where ambient temperature does not surpass the value specified in the technical data.  
 In order for the panel mounting units to be suitable having IP65 protection, the gasket should be properly installed between the apparatus and the perimeter of the panel cut-out where it is to be fitted.  
 In order to give a correct reading, the probe should be installed in a place without heat influences other than the temperature that is to be measured or controlled.

### 3.1 Fastening units for panel mounting:

To fix the unit, place the fasteners **1** over the sliders **2** as shown in the figure. Move the fasteners in the direction of the arrow. By pressing tab **3** fasteners may be moved in the opposite direction of the arrow.

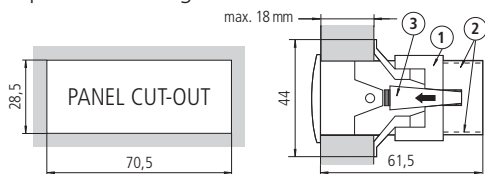

### 3.2 Fastening units for DIN rail mounting:

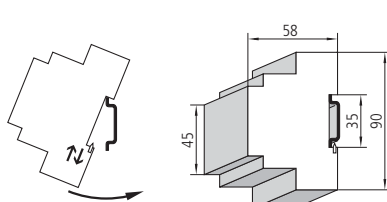

### 3.3 Connection:

See diagram in the unit rating plate.

The probe and its lead should NEVER be installed in ducting along with power, control or power supply wiring.

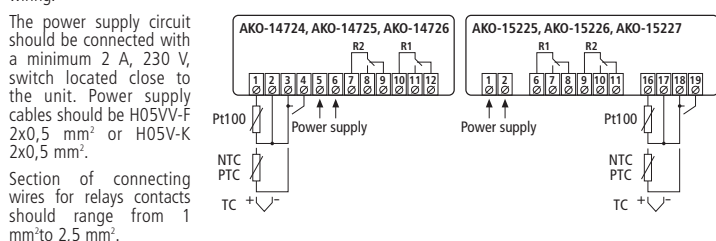

## 4- Front panel functions

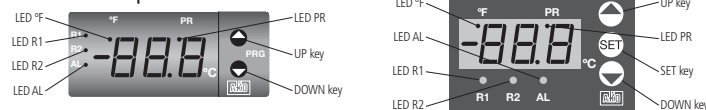

**LED R1:** Relay 1 indicator enabled  
**LED R2:** Relay 2 indicator enabled  
**LED AL:** Alarm indicator enabled  
**LED PR:** Flashing, programming phase  
**LED °F:** Degrees °F indicator  
**UP key** Press once to cancel the alarms, but they remain displayed (optional by parameter **AtA**). When pressed for at least 5 seconds, the SP1 Set Point temperature of Relay **R1** is displayed. In programming, it makes the displayed value increase.  
**SET Key** Press once to cancel the alarms, but they remain displayed (optional by parameter **AtA**). In programming, it accepts the modified value.  
**DOWN key** Press once to cancel the alarms, but they remain displayed (optional by parameter **AtA**). When pressed for at least 5 seconds, the SP2 Set Point temperature of Relay **R2** is displayed. In programming, it makes the displayed value reduce.

## 5- Adjustment and configuration

It should only be programmed or modified by personnel who are fully conversant with the equipment operation and possibilities.

### 5.1 Set Point temperature

The factory SET POINT default value is 0 °C.

- Press key for at least 5 seconds to DISPLAY SET POINT in Relay R1 or key for Relay R2. It displays the CURRENT SET POINT value and LED "PR" starts flashing.
- Press or keys to CHANGE SET POINT into the required value.
- Press the ACCEPT THE NEW keys to ACCEPT THE NEW SET POINT. The display returns to the CURRENT TEMPERATURE display status and LED "PR" stops flashing.

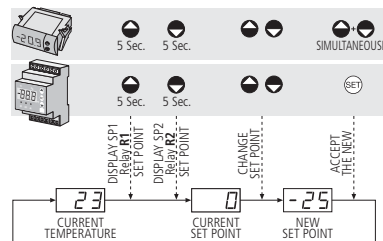

### 5.2 Parameters configuration

**Level 1 Menus**

- Press + simultaneously for at least 10 seconds. The LED "PR" will be flashing, we are in the programming LEVEL 1 MENUS and the first menu "Po1" is displayed.
- Press key to access the next menu and key to return to the previous one.
- Pressing DISPLAY PARAMETER keys in the last menu EP, the controller returns to the CURRENT TEMPERATURE display status and LED "PR" will stop flashing.

When **PA** is displayed, PASSWORD programmed in **PAS** parameter of **Par** menu should be entered to access programming LEVEL 1 MENUS.

- Press ACCEPT keys. 0 will be displayed to ENTER PASSWORD.
- Press or keys to CHANGE NUMBER and DISPLAY PASSWORD programmed.
- Press ACCEPT PASSWORD keys. The first menu "Po1" will be displayed.

**Level 2 Parameters**

- In the desired menu of LEVEL 1 MENUS, press keys DISPLAY PARAMETER. LEVEL 2 PARAMETERS programming is accessed. The first parameter of the selected menu is displayed on the screen.
- Press key to access the next parameter and key to return to the previous one.
- Pressing DISPLAY VALUE keys in the last parameter EP, the controller returns to the LEVEL 1 MENUS.

**Level 3 Values**

- To DISPLAY CURRENT VALUE of any parameter, select the required one and press DISPLAY VALUE. Once it is displayed, you can CHANGE VALUE pressing or key.
- Press ACCEPT THE NEW keys. The programming returns to LEVEL 2 PARAMETERS.

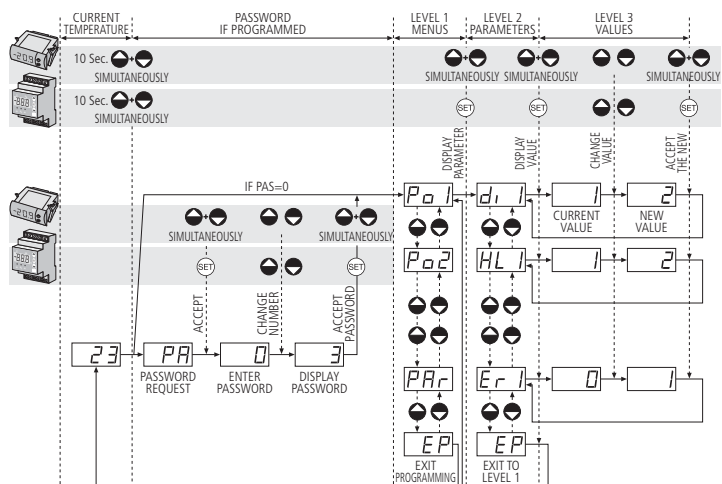

**REMARK:** If no key is pressed for 25 seconds in either of the previous steps, the controller will automatically return to the CURRENT TEMPERATURE display status without modifying any of the parameters values.

## 6- Menus, parameters and messages

Values in the **Def.** column are factory-set.

In programming, it must be taken into consideration that the parameters and values displayed depend on the option selected in the **CFo** configuration menu **o2C** parameter.

Level 1	Menus and Description			
Po1	Level 2	R1 Relay Parameter Output		
	Level 3	Description	Values	Min. Def. Max.
	di1	R1 and SP1 Differential (Hysteresis)	(°C/°F)	-50 1 50
	HL1	Set Point upper limit SP1 of R1 (It cannot be set above this value)	(°C/°F)	LL1 999 999
	LL1	Set Point lower limit SP1 of R1 (It cannot be set below this value)	(°C/°F)	-99 -99 HL1
	HC1	Type of operation R1: (0=Cold) (1=Heat) (If o2C≠3)		0 1 1
	Er1	R1 relay status with faulty sensor: 0=OFF 1=ON		0 0 1
	EP	Exit to Level 1		
Po2	Level 2	R2 Relay Parameter Output (If o2C=1 or 2)		
	Level 3	Description	Values	Min. Def. Max.
	di2	R2 and SP2 Differential (Hysteresis)	(°C/°F)	-50 1 50
	HL2	Set Point upper limit SP2 of R2 (It cannot be set above this value)	(°C/°F)	LL2 999 999
	LL2	Set Point lower limit SP2 of R2 (It cannot be set below this value)	(°C/°F)	-99 -99 HL2
	HC2	Type of operation R2: (0=Cold) (1=Heat) (If o2C=1)		0 1 1
	Er2	R2 relay status with faulty sensor: 0=OFF 1=ON		0 0 1
	EP	Exit to Level 1		
Cf0	Level 2	Configuration Parameters		
	Level 3	Description	Values	Min. Def. Max.
	o2C	R2 Relay output ratio type: (1=Two independent stages) (2=Two related stages) (3=Neutral Zone) (4=1 Stage + alarm)		1 1 4
	Pb5	Sensor type selection (Pt1, HtC, JtC, ntc, PtC)		Pt1
	CAn	Sensor calibration (Offset)	(°C/°F)	-20 0 20
	rES	Temperature display mode: (0=Integers in °C) (1=One decimal in °C) except in thermocouples		0 0 1
	CdF	Temperature display mode in °C or °F: (0=°C) (1=°F)		0 0 1
	toF	Delay time for the relays to switch ON	(sec.)	0 0 250
	ton	Delay time for the relays to switch OFF	(sec.)	0 0 250
	EP	Exit to Level 1		
ALA	Level 2	Alarm Parameters		
	Level 3	Description	Values	Min. Def. Max.
	ACo	Alarm configuration: (0=Absolute) (1=Related to set point SP1 of R1)		0 0 1
	ALT	Minimum alarm: (Limited by Aht)	(°C/°F)	-99 -99 Aht
	Aht	Maximum alarm: (Limited by Alt)	(°C/°F)	Alt 999 999
	Adi	Alarm differential	(°C/°F)	1 1 20
	AdE	Alarm delay from the moment at which they should be enabled	(min)	0 0 250
	Ado	Alarm delay at start-up	(min)	0 0 250
	Arc	Polarity configuration of the alarm relay: (In the event of an alarm, relay ON) (1=In the event of an alarm, relay OFF)		0 0 1
	AtA	Optional cancellation of output alarms by pressing once a key: (0=Allows to cancel the output alarms) (1=Not allows to cancel the output alarms)		0 0 1
	EP	Exit to Level 1		
InP	Level 2	Digital Input Parameters		
	Level 3	Description	Values	Min. Def. Max.
	ICF	Digital input configuration: (0=Disabled) (1=External alarm) (2=R1 Relay set point SP1 variation) (3=Inversion type of operation HC1)		0 0 3
	IPo	Digital output status inversion: (0=Closed contact) (1=Open contact)		0 0 1
	IdY	Digital input enabling delay	(min)	0 0 120
	US1	R1 Relay set point SP1 variation if ICF=2	(°C/°F)	-99 0 999
	tSI	US1 variation length	(min)	0 0 254
	EP	Exit to Level 1		
PAR	Level 2	General Parameters		
	Level 3	Description	Values	Min. Def. Max.
	CYt	R1 Relay output switching off frequency	(h)	0 6 120
	oFt	R1 Relay output switching off time	(min)	0 0 120
	PdE	Initial parameters: (1=YES, configure to "Def" and exit programming)		0 0 1
	PtR	Parameters transfer: (0=Disabled) (1=Send) (2=Receive)		0 0 2
	PAS	Access password to parameters and information		0 0 250
	CAd	Address for units with communication		0 0 250
	PU	Program version (Information)		
	EP	Exit to Level 1		
	EP	Exit programming		

MESSAGES	
AH	The Sensor temperature exceeds the parameter programmed in Aht
AL	The Sensor temperature is lower than the parameter programmed in Alt
EAL	Active digital input
E1	Sensor failure (Open circuit, crossed, out-of-scale temperature)
- - -	Temperature > 999 °F/°C
EE	Memory failure
PA	Password request to enter programming parameters

**REMARK:** When time and alarm parameters are modified, the new values are applied once the current cycle is completed. In order for it to have an immediate effect, switch the controller off and then on again.

## 7- Parameters transfer

**AKO-14918** portable server, with no power supply, in which parameters programmed in a powered controller can be copied by transfer. Parameters can be transferred again from the server to other identical powered controllers. Panel mounting or DIN rail models

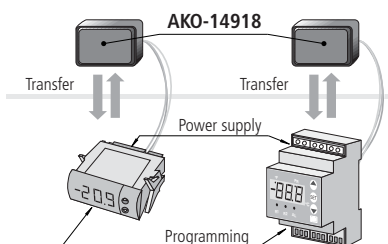

## 8- R1 and R2 relay operation and control

SP1 = R1 Relay set point

SP2 = R2 Relay set point

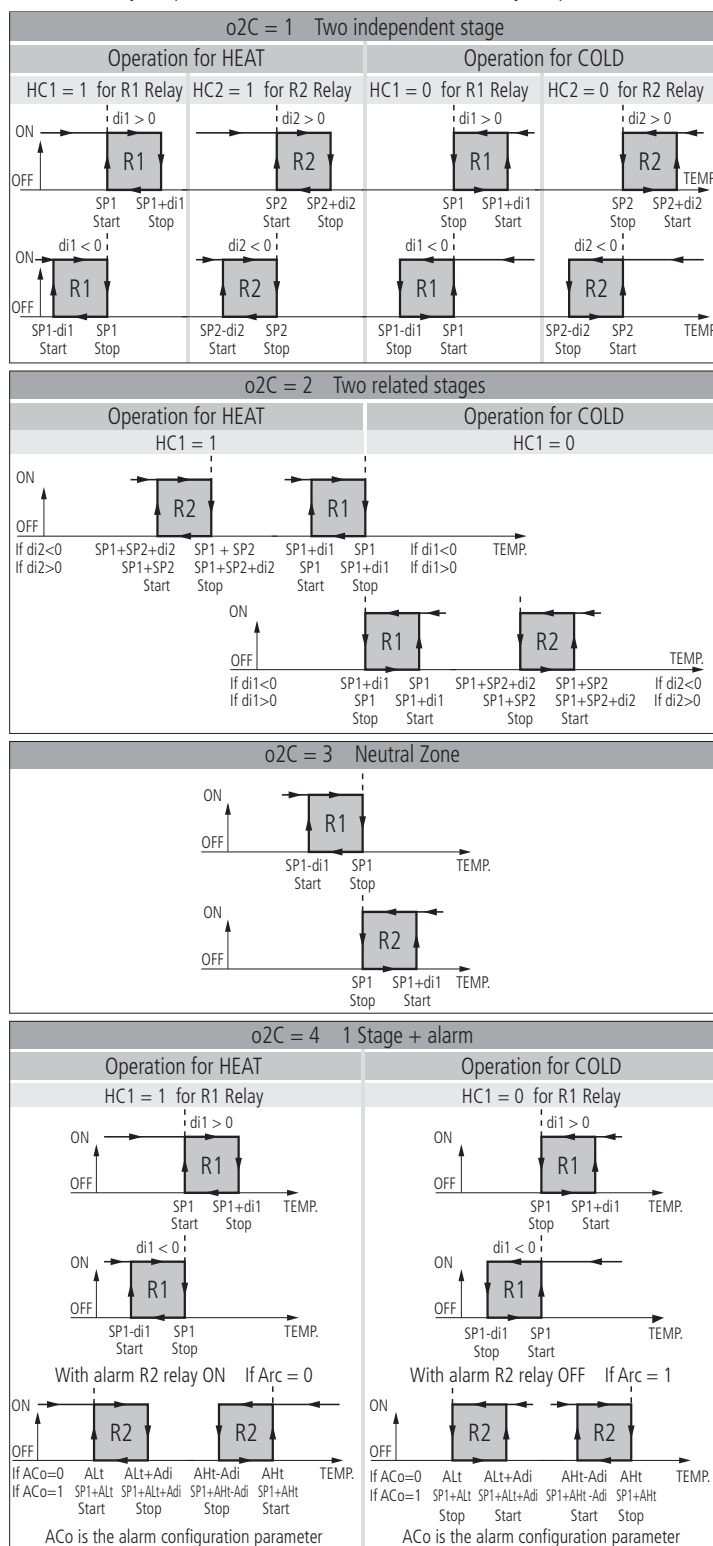

## 9- Maintenance

Clean the controller surface with a soft cloth and soap and water. Do not use abrasive detergents, petrol, alcohol or solvents.

## 10- Warnings

The use of the unit without observing the manufacturer's instructions may alter its safety qualification. To ensure correct operation of the apparatus, only probes supplied by AKO should be used.